

THE INFORMATION CONTAINED WITHIN THIS DOCUMENT(S) IS THE SOLE PROPERTY OF INFINITY BELTING LTD. NO REPRODUCTION IS AUTHORIZED WITHOUT WRITTEN PERMISSION FROM INFINITY BELTING LTD.

Title: **PRESENTATION VIEW**

UNLESS OTHERWISE SPECIFIED  THIRD ANGLE PROJECTION



17 Goertz Ave
Stony Plain, Alberta
Canada T7Z0H6

Product #: **IBLS-56-B**

Sheet Series:
2021

TOLERANCES:
ZERO PLACE DECIMAL `0.060
TWO PLACE DECIMAL `0.045
THREE PLACE DECIMAL `0.010, ANGULAR `1°

Scale:
1 : 8

DIMS:
INCH

Sheet:
1 of 2

Rev.
A

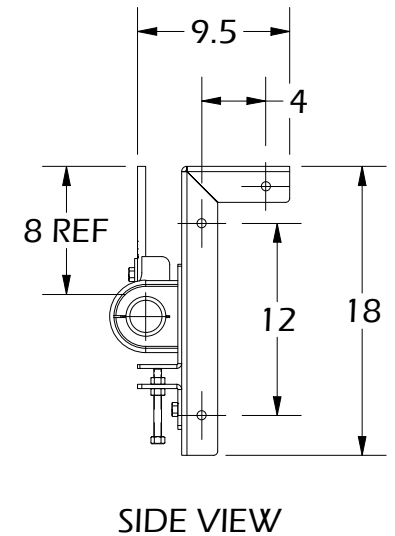
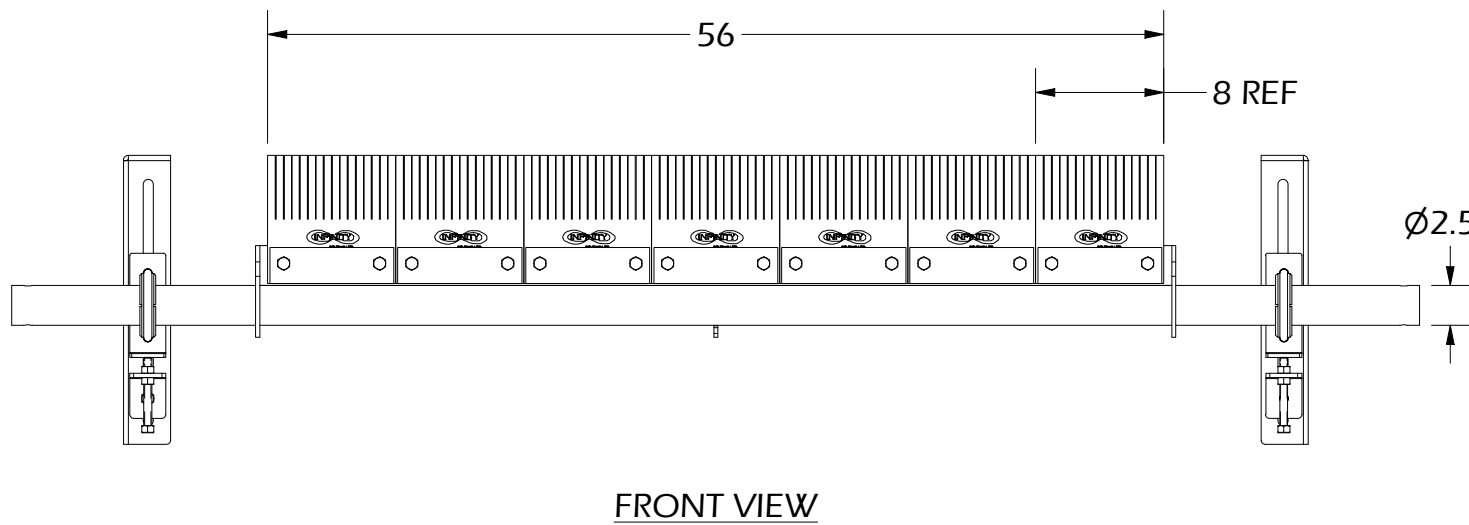
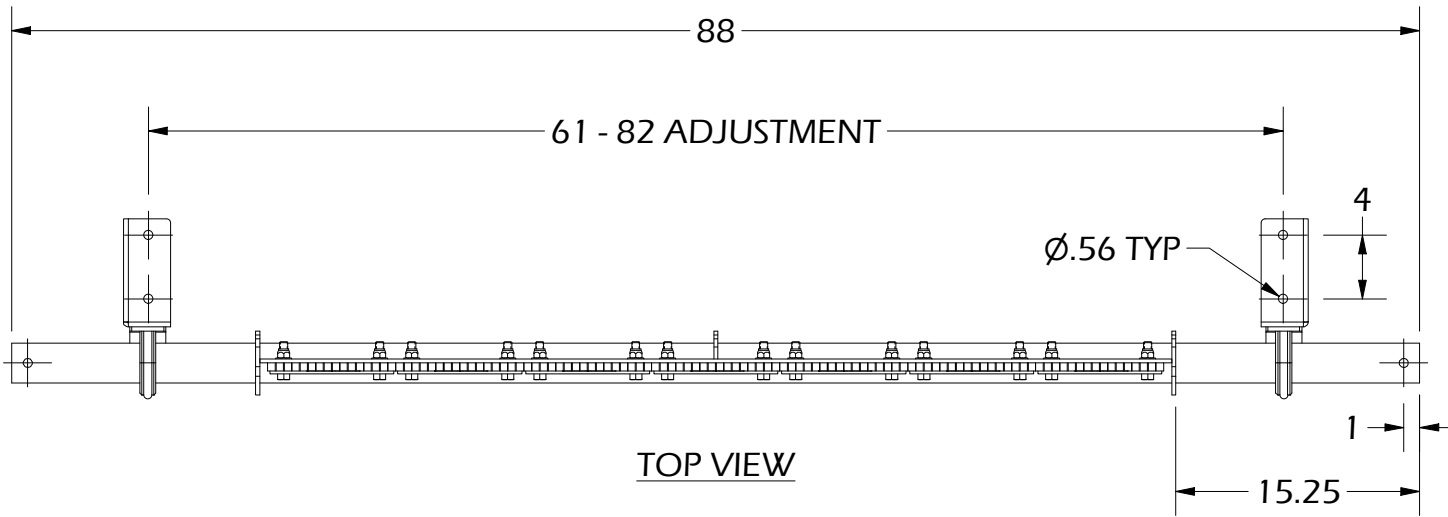

THE INFORMATION CONTAINED WITHIN THIS DOCUMENT(S) IS THE SOLE PROPERTY OF INFINITY BELTING LTD. NO REPRODUCTION IS AUTHORIZED WITHOUT WRITTEN PERMISSION FROM INFINITY BELTING LTD.

Title: **OVERALL DIMENSIONS**

Product #: **IBLS-56-B**

UNLESS OTHERWISE SPECIFIED  THIRD ANGLE PROJECTION

TOLERANCES:
 ZERO PLACE DECIMAL `0.060
 TWO PLACE DECIMAL `0.045
 THREE PLACE DECIMAL `0.010, ANGULAR `1°



17 Goertz Ave
 Stony Plain, Alberta
 Canada T7Z0H6

Sheet Series:
2021

Scale:
1 : 12

DIMS:
INCH

Sheet:
2 of 2

Rev.
A