

THE INFORMATION CONTAINED WITHIN THIS DOCUMENT(S) IS THE SOLE PROPERTY OF INFINITY BELTING LTD. NO REPRODUCTION IS AUTHORIZED WITHOUT WRITTEN PERMISSION FROM INFINITY BELTING LTD.

Title: **PRESENTATION VIEW**

UNLESS OTHERWISE SPECIFIED  THIRD ANGLE PROJECTION



17 Goertz Ave
Stony Plain, Alberta
Canada T7Z0H6

Product #: **IBLS-40-B**

Sheet Series:
2021

TOLERANCES:
ZERO PLACE DECIMAL `0.060
TWO PLACE DECIMAL `0.045
THREE PLACE DECIMAL `0.010, ANGULAR `1°

Scale:
1 : 7

DIMS:
INCH

Sheet:
1 of 2

Rev.
A

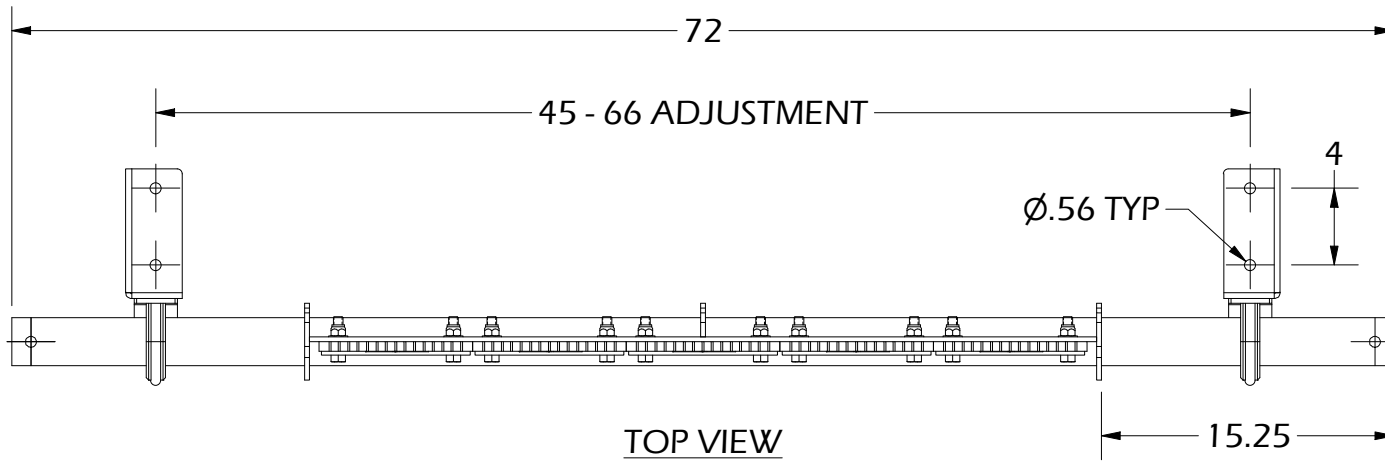

TOP VIEW

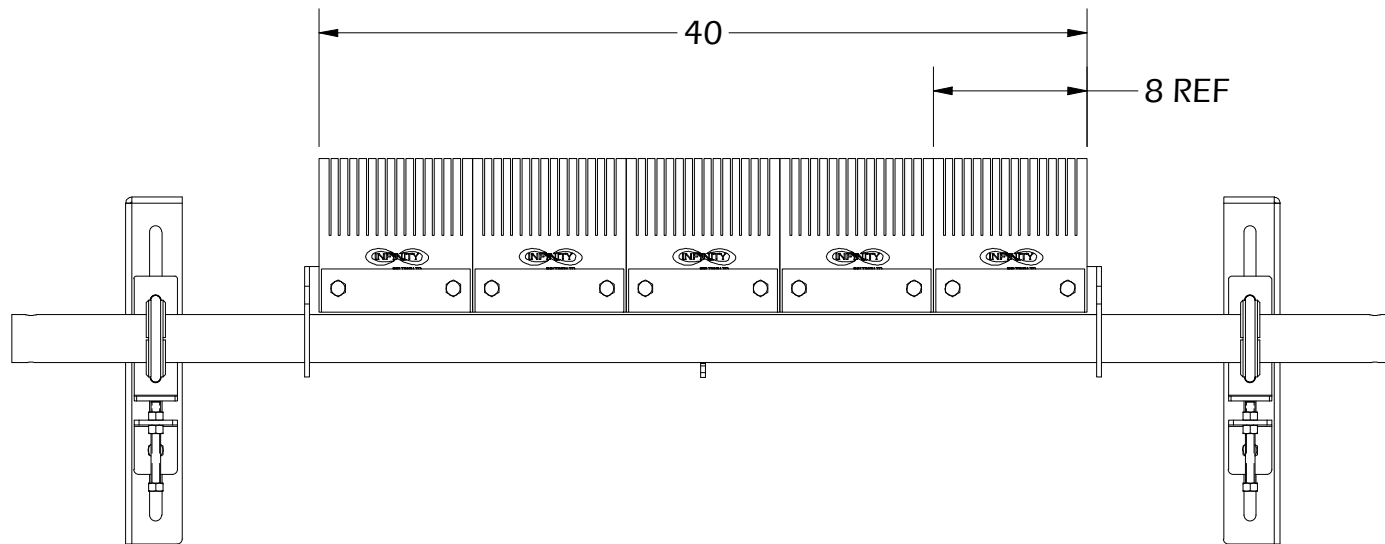

FRONT VIEW

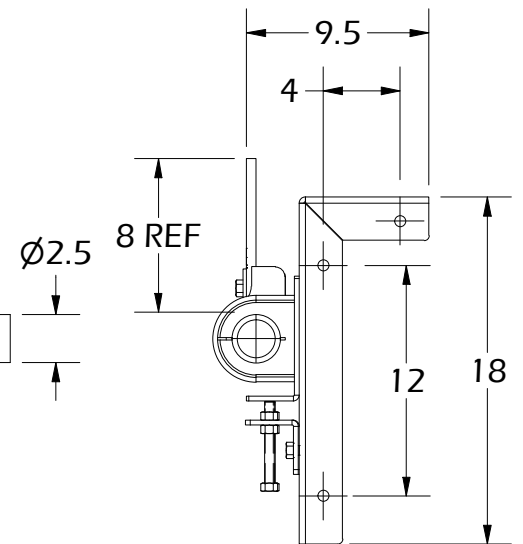

SIDE VIEW

THE INFORMATION CONTAINED WITHIN THIS DOCUMENT(S) IS THE SOLE PROPERTY OF INFINITY BELTING LTD. NO REPRODUCTION IS AUTHORIZED WITHOUT WRITTEN PERMISSION FROM INFINITY BELTING LTD.

Title: **OVERALL DIMENSIONS**

Product #: **IBLS-40-B**

UNLESS OTHERWISE SPECIFIED  THIRD ANGLE PROJECTION

TOLERANCES:
 ZERO PLACE DECIMAL `0.060
 TWO PLACE DECIMAL `0.045
 THREE PLACE DECIMAL `0.010, ANGULAR `1°



17 Goertz Ave
 Stony Plain, Alberta
 Canada T7Z0H6

Sheet Series:
2021

Scale:
1 : 10

DIMS:
INCH

Sheet:
2 of 2

Rev.
A